

SINGLE SINK WITH LEFT HAND BENCH



This 610 mm sink range is modular to the Brayco 610 mm deep cabinets, benches and splashback benches.



610 SERIES SINKS

Overall Dimensions:

1350 (w) x 610 (d) x 1050 mm (h)

Bowl Size:

500 (w) x 400 (d) x 300 mm (h)

Capacity: 60 L

Shipping Dimensions:

Sink: 1350 (w) x 610 (d) x 460 mm (h)

Legs: 1230 (w) x 170 (d) x 100 mm (h)

Shipping Weight: 27.4 kg

Material:

Top: 1.2 mm 304 grade stainless steel

Legs: 201 grade 42 mm diameter stainless steel

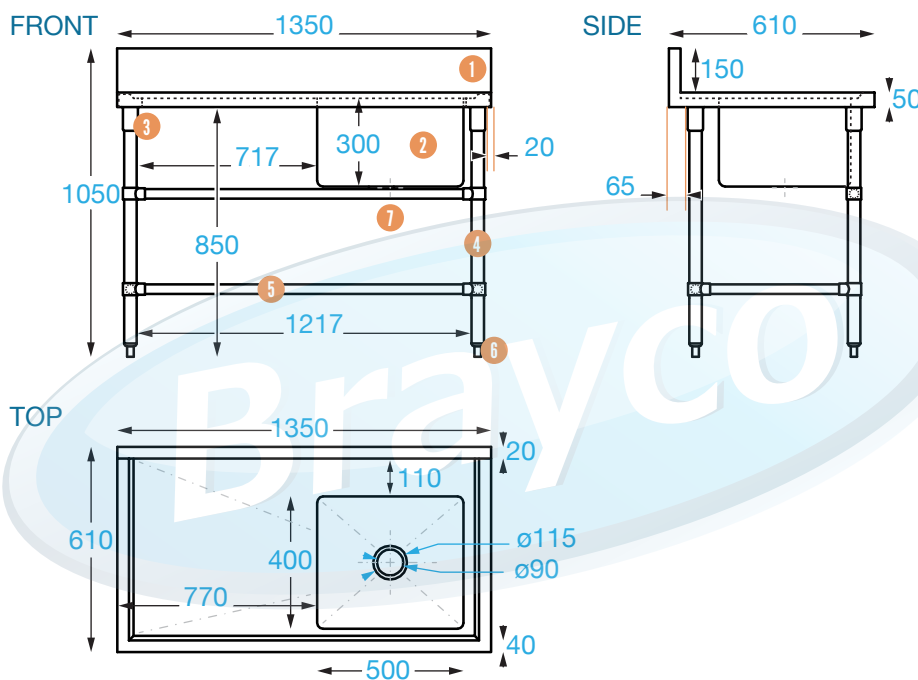

PRODUCT CODE: SSL610

 Brayco Stainless Steel is made from 95% recycled materials

FEATURES AND BENEFITS



- Sink Drainer Included.
- Construction: Our units are fully stainless steel. Very sturdy.
- Bowl: Fully welded for strength and superior durability.
- Tap Location: Untapped to allow for universal plumbing as required.
- Bar work: Fully adjustable to accommodate glass or dishwasher, shelf etc.
- Supplied Flat Packed: Simple assembly, instructions included.

COMPONENTS

- | | | |
|---|----------------------------|-----------------------------|
| 1 | Splashback | 150 mm (high), 20 mm (deep) |
| 2 | Fully welded bowl | 60 ltr capacity |
| 3 | Welded sockets | 1.2 mm |
| 4 | Stainless legs | Ø 42 |
| 5 | Rails (back, front & side) | Ø 32 |
| 6 | Adjustable feet | up to 35 mm (max) |
| 7 | Waste outlet | 90 mm (diameter) |

DIMENSIONS

OPTIONS

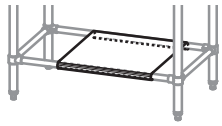
- **Splashback Extension:**  Convert your sink to a corner unit.
- **Slatted Sink Cover:** Ideal drainer tray or to rinse food.  Code: SCH400
- **Sink Cover:** Create extra work space with a stainless steel sink cover.  Code: SCB400
- **Under-sink shelf:** 650 mm long removable clip-on stainless shelf. 

Code: SHELFSINK610

 Can accommodate an under bench dishwasher of up to 850 x 580 x 550 mm (HxLxD).

 These products are compliant with all applicable Australian health department regulations.

 It is important that your stainless steel is kept clean to extend the lifetime of the product.



Brisbane • Sydney • Melbourne • Hobart • Adelaide • Perth • Auckland
For more info please contact your nearest Brayco Branch 1300 272 926 | brayco.com.au