

LAIARM

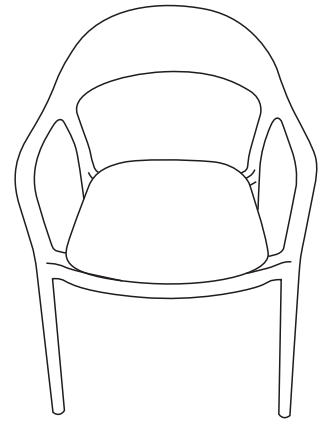



Assembly Instructions Lai Armchair

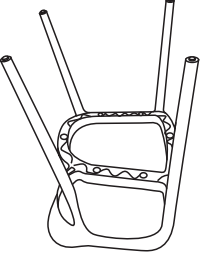
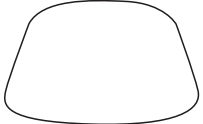
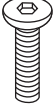

Before assembly please check you have all parts listed below.
PLEASE NOTE: We've tried to make this chair as easy to assemble as possible.
In the unlikely event you have problems putting it together or missing pieces, please contact us.
Details below.

PARTS LIST

| | | | | |
|---|---|--|--|--|
| <p>A frame</p>  <p>X 1</p> | <p>B seat</p>  <p>X 1</p> | <p>C</p>  <p>X 6</p> | <p>D</p>  <p>X 6</p> | <p>E</p>  <p>X 1</p> |
|---|---|--|--|--|

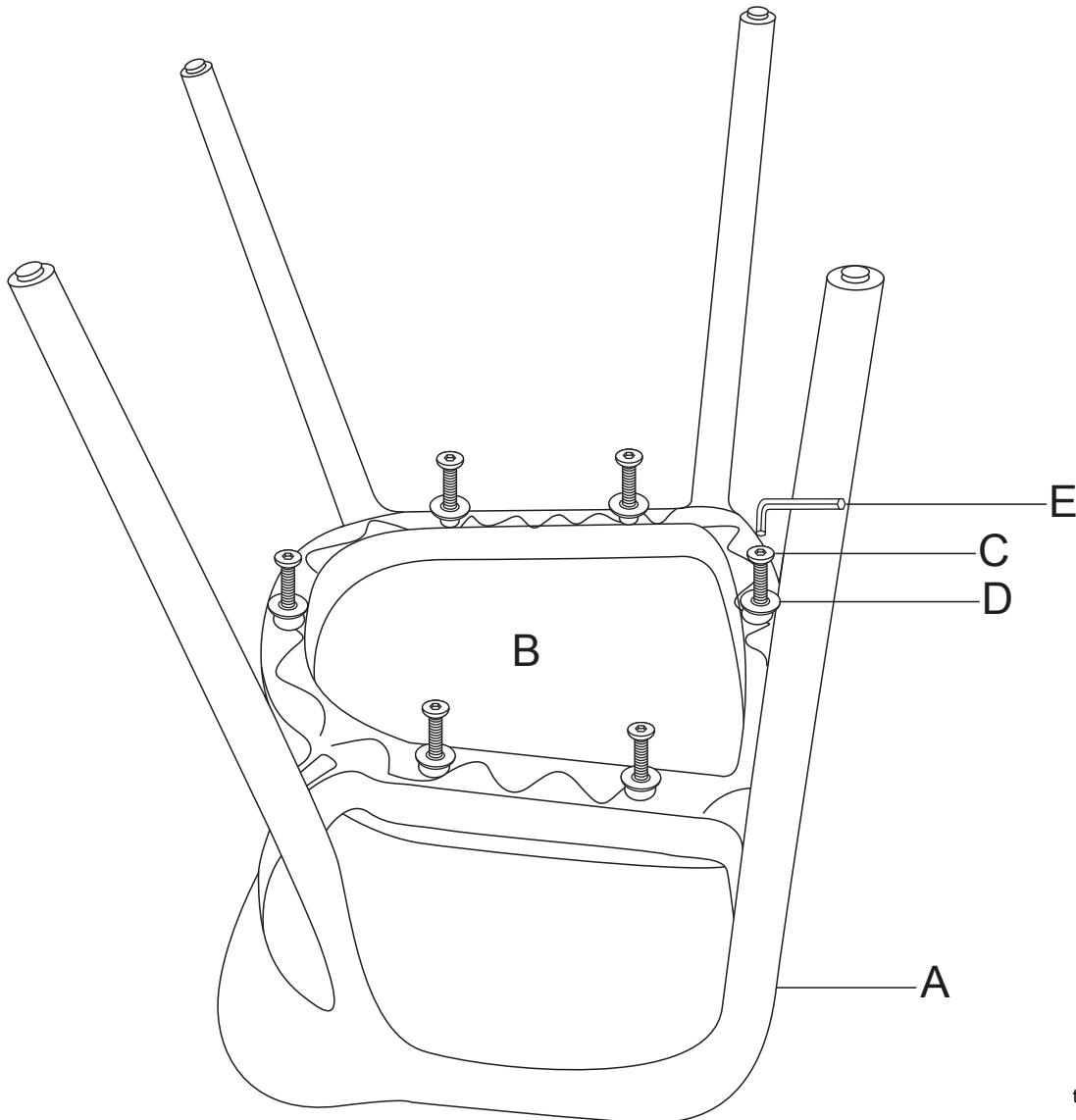

Please recycle these instructions

Thank you for your purchase. Lai chairs are exclusively supplied by Chairforce.
To learn more about our products please visit www.chairforce.com.au and www.chairforce.co.nz

AU: Call: 08 9436 8570 Email: customer@brayco.com.au
NZ: Call: 09 271 5000 Email: sales@chairforce.co.nz

