

DOUBLE SINK WITH LEFT AND RIGHT HAND BENCH



This 700 mm sink range is modular to the Brayco 700 mm deep cabinets and splashback benches.



700 SERIES SINK

Overall Dimensions:

2000 (w) x 700 (d) x 1050 mm (h)

Bowl Size:

500 (w) x 450 (d) x 300 mm (h) each

Capacity: 67 L each

Shipping Weight: 40.8 kg

Shipping Dimensions:

Sink: 2000 (w) x 700 (d) x 460 mm (h)

Legs: 1880 (w) x 170 (d) x 100 mm (h)

Material:

Top: 1.2 mm 304 grade stainless steel

Legs: 201 grade 42 mm diameter stainless steel

FRONT

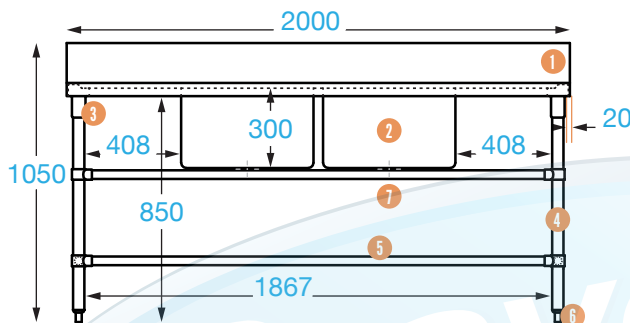

SIDE

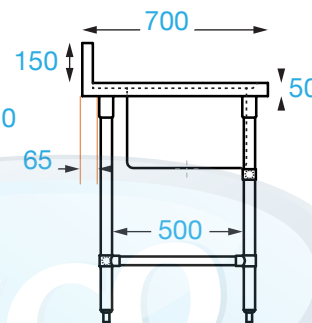

TOP

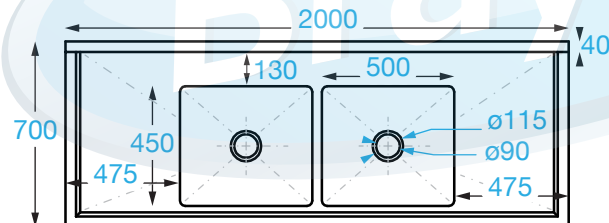

COMPONENTS

- 1 Splashback
- 2 Fully welded bowls
- 3 Welded sockets
- 4 Stainless legs
- 5 Rails (back, front & side)
- 6 Adjustable feet
- 7 Waste outlet

DIMENSIONS

- 150 mm (high), 40 mm (deep)
- 65 ltr capacity
- 1.2 mm
- Ø 42 mm
- Ø 32 mm
- up to 35 mm (max)
- 90 mm (diameter)



These products are compliant with all applicable Australian health department regulations.



It is important that your stainless steel is kept clean to extend the lifetime of the product.

PRODUCT CODE: DSRL2000





Brayco Stainless Steel is made from 95% recycled materials

FEATURES AND BENEFITS

- Sink drainer Included.
- Construction: Our units are fully stainless steel. Very sturdy.
- Bowl: Fully welded for strength and superior durability.
- Tap Location: Untapped to allow for universal plumbing as required.
- Bar work: Fully adjustable.
- Supplied Flat Packed: Simple assembly, instructions included.

OPTIONS

- **Splashback Extension:**  Convert your sink to a corner unit.
- **Slatted Sink Cover:** Ideal drainer tray or to rinse food.  Code: SCH500
- **Sink Cover:** Create extra work space.  Code: SCB500
- **Under-sink shelf:** 650 mm long stainless steel shelf.

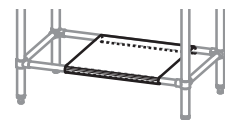

Code: SHELSINK700



Brisbane • Sydney • Melbourne • Hobart • Adelaide • Perth • Auckland
For more info please contact your nearest Brayco Branch 1300 272 926 | brayco.com.au