

FLAT BENCH 610mm DEEP



This 610 mm bench range is modular to the Brayco 610 mm deep sinks and splashback benches.

610 SERIES FLAT BENCH

Overall Dimensions:

2438 (w) x 610 (d) x 900 mm (h)

Loading Capacity:

Top: 380 kg, Undershelf: 120 kg

Shipping Dimensions:

2460 (w) x 740 (d) x 150 mm (h)

Shipping Weight: 61 kg

Material:

Top: 1.2 mm 304 grade stainless steel

Undershelf: 1.2 mm galvanised steel

Legs: 410 grade 42 mm diameter stainless steel

FRONT

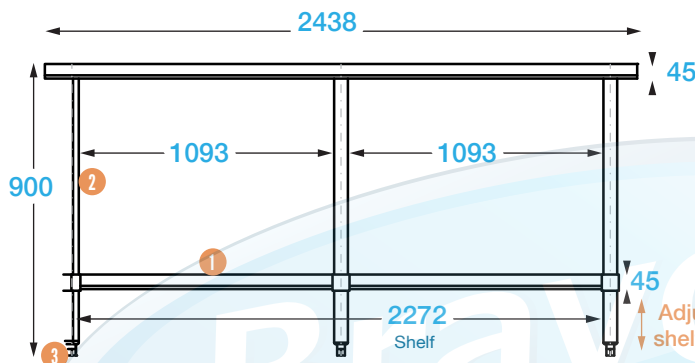

SIDE

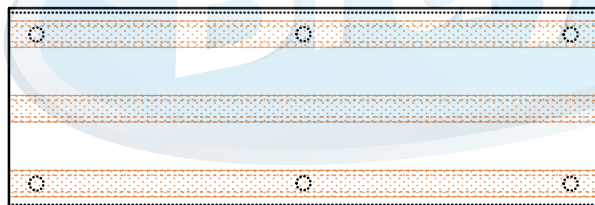
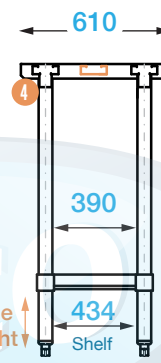

REINFORCED BENCH TOPS

610 mm deep benches of 1524 mm to 2438 mm length feature a third bar that ensures bench top strength and stability.

PRODUCT CODE: 2496



Brayco Stainless Steel is made from 95% recycled materials

FEATURES AND BENEFITS

- Adjustable Height Undershelf.
- High Grade Stainless Steel.
- Supplied Flat Pack: Simple assembly required.
- Construction: Our units are fully stainless steel with round legs and galvanised undershelf.
- Adjustable Feet: Supplied attached to leg. See additional items below for upgrade options.

COMPONENTS

- 1 Galvanised undershelf
1.2 mm (height adjustable)
- 2 Stainless steel legs
Ø 42 mm
- 3 Adjustable feet
Adjustable up to 18 mm
- 4 Welded sockets
1.2 mm



These products are compliant with all applicable Australian health department regulations.





It is important that your stainless steel is kept clean to extend the lifetime of the product.

LEG UPGRADES

- 201 Grade Stainless Legs & Feet: For extremely salty or chemical conditions. Feet adjust up to 38 mm.
- 410 Grade Stainless Legs & Lockable Castors
- 201 Grade Stainless Legs & Lockable Castors: For extremely salty or chemical conditions.
- 410 Grade Stainless Steel Legs & Screw Down Feet: Adjustable up to 20 mm.
- 201 Grade Stainless Steel Legs & Screw Down Feet: Adjustable up to 20 mm.

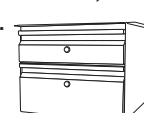
ADDITIONAL ITEMS

- 430 Grade Stainless Undershelf: For extremely salty or chemical conditions.
- Leg Brace Rail Kit:  Remove the undershelf and add a rail kit for extra strength. Allows for extra storage such as a dishwasher, washing machine, etc.
- Lockable Drawers:  Add a unit with 1 or 2 lockable drawers.
- Leg attachments: Enclose  your bench by attaching panels.
- Overshelves: 2 tier overshelves sit on top of bench.
- Extra shelves also available 



Brisbane • Sydney • Melbourne • Hobart • Adelaide • Perth • Auckland
For more info please contact your nearest Brayco Branch 1300 272 926 | brayco.com.au