

SPLASHBACK BENCH 700mm DEEP



This 700 mm splashback bench range is modular to the Brayco 700 mm deep sink and cabinet.

700 SERIES SPLASHBACK BENCH

Overall Dimensions:

1800 (w) x 700 (d) x 900 mm (h)

Splashback Height: 150 mm

Loading Capacity:

Top: 260 kg, Undershelf: 100 kg

Shipping Dimensions:

Bench: 1820 (w) x 720 (d) x 260 mm (h)

Shipping Weight: 57 kg

Material:

Top: 1.2 mm 304 stainless steel

Undershelf: 1.2 mm galvanised steel

Legs: 410 grade 42 mm diameter stainless steel

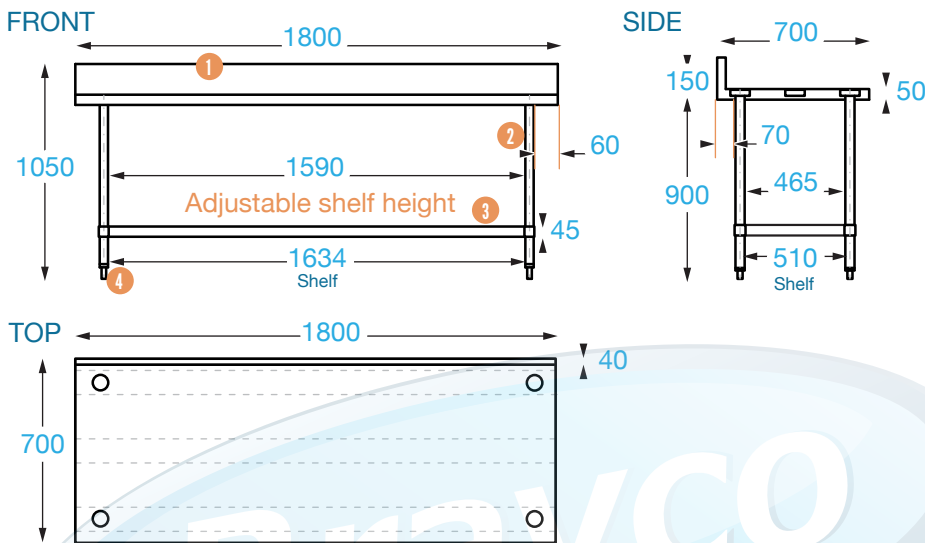

PRODUCT CODE: 18070SP

Brayco Stainless Steel is made from 95% recycled materials

FEATURES AND BENEFITS

- Adjustable Height Undershelf.
- High Grade Stainless Steel.
- Supplied Flat Pack: Simple assembly required.
- Construction: Our units are fully stainless steel with round legs.
- Adjustable Feet: Supplied attached to leg. See additional items below for upgrade options.

COMPONENTS

- 1 Splashback
150 mm (high), 40 mm (deep)
- 2 Legs
Ø 42 mm
- 3 Undershelf
1.2 mm (adjustable height)
- 4 Adjustable feet
Feet adjust up to 18 mm

LEG UPGRADES

- 201 Grade Stainless Legs & Feet: For extremely salty or chemical conditions. Feet adjust up to 38 mm.
- 410 Grade Stainless Legs & Lockable Castors
- 201 Grade Stainless Legs & Lockable Castors: For extremely salty or chemical conditions.
- 410 Grade Stainless Steel Legs & Screw Down Feet: Adjustable up to 18 mm.
- 201 Grade Stainless Steel Legs & Screw Down Feet: Adjustable up to 20 mm.

ADDITIONAL ITEMS

- 430 Grade Stainless Undershelf: For extremely salty or chemical conditions.
- Overshelves: 2 tier overshelves sit on top of bench.
- Leg Brace Rail Kit: Remove the undershelf and add a rail kit for extra strength.
- Leg attachments: Enclose your bench by attaching panels.
- Splashback Extension: Convert your bench to a corner unit. Code: CSB700
- Lockable Drawers: Add a unit with 1 or 2 lockable drawers.
- Extra shelves available

These products are compliant with all applicable Australian health department regulations.

It is important that your stainless steel is kept clean to extend the lifetime of the product.



Brisbane • Sydney • Melbourne • Hobart • Adelaide • Perth • Auckland
For more info please contact your nearest Brayco Branch 1300 272 926 | brayco.com.au