



Stainless Steel

Established 2003

09 271 5000
braycostainless.co.nz



BENCHES

from \$179

- From 400mm to 2438mm
- 5 depths
- Flat or splashback
- Many extras available



CABINETS

from \$629

- Many sizes
- Drawer & sink options
- BBQ Cabinets
- Castors or feet



SINKS

from \$539

- 1, 2 or 3 bowls
- Inset sinks
- 450, 610 or 700mm deep
- Rails or undershelves available
- With benches or standalone



TAPS

from \$139

- Handsfree
- Kitchen mixers
- Spray & jet nozzles



WALL MOUNTED SINKS

from \$104

- Knee operated
- Corner basin
- Handbasin
- Mop sinks



from \$179

15% THICKER
Compare the quality!

CHROME / EPOXY

- 24 Sizes
- Extra shelves
- Thicker than competing units



from \$84

SHELVES

- Stainless steel
- Overbench units
- Pipe shelves
- Wall mounted



from \$609

PREMIUM COOLROOM SHELVES

- Strong
- Fits any space
- Aluminium frame - NO RUST
- Dishwasher safe
- 10 year warranty



from \$199

TROLLEYS

- Polypropylene
- Stainless steel
- 2 or 3-tier
- Add-on bins



450+ PRODUCTS
and growing!

Over 200,000 Benches Sold • Over 50,000 Sinks Sold • 100,000 Happy Customers

SCAN & VIEW
MORE ONLINE



sales@braycostainless.co.nz | Open 9am to 5pm Monday to Friday

Contents

Wall shelves	3
Flat, pipe, corner	
4-Tier Stainless Steel Shelf Unit	3
2-Tier Overshelves	3
Benches	4 - 5
450, 457, 610, 762, 914mm deep	
Folding benches	
Drawers for benches	
Upgrade your undershelf	
Leg attachments (enclose a bench)	
Leg brace rail kits	
(remove an undershelf & add a dishwasher, bin etc)	
Splashback Benches	6-7
450, 610 and 700mm deep	
Splashback extensions	
Waste collection bench	
Lockable drawers	
Leg brace rail kits	
Sinks	8-9
450, 610 & 700mm deep	
Sink shelves	
Splashback extensions	
Sink covers	
Wall Mounted Sinks	9
Handsfree, corner & mop sinks	
Dishwasher Inlet & Outlet Benches	10
700mm deep benches	
700mm deep sinks	
Taps	11
Handsfree, mixer, pot filler, pre rinse units	
Cabinets	12-13
610 & 700mm deep cabinets	
Coffeecart	
Drawer cabinets	
Wall cabinets	
Sink cabinets	
Splashback extensions	
Overshelves	
Coolroom Shelving	14 - 15
Plastic/aluminium shelving	
Epoxy shelving (page 16)	
Chrome & Epoxy Shelving	16 - 17
Shelving units	
Shelf dividers	
S-hooks	
Trolleys	18
Polypropylene or stainless steel	
Medical	
Add-on bins	
Dunnage Racks	19
Chairforce Range	19
Brayco Story - 20 Years of History	20



Welcome to Brayco

Do you want to be the best in the business? We do. Of course 'the best' is subjective, so for us it means providing the highest quality steel benches, sinks and shelves at low prices for great customers. Cast your eyes over the full range inside to spark inspiration for what will work for your commercial space. Brayco has been around for 20 years and we're still growing, but if you need further convincing that our most excellent products and service are for you, visit us in-store or give us a call 09 271 5000

Why are you so much cheaper than your competitors?

Seriously, we are asked this question all the time. The answer is that we directly import from an enormous Chinese manufacturer. We sell direct to the customer. No distributors. No middlemen. Also, we keep overheads down and we price the products accordingly.

Do you deliver? Can I pick up? How much to freight it?

We deliver coast-to-coast around New Zealand but of course you are welcome to pick up from our Auckland branch, or use your own courier. Give us a call and we can give you an accurate price to get your order to you quickly and without fuss.

Can you make up a bench to a specific size?

No, we don't manufacture to size. We stock a large variety of bench sizes and we are confident we can configure a bench layout to fit most spaces. However, if you require 50 or more benches of a specific size, please call us to discuss.

Do you have everything in stock?

Yes, almost always. We believe that we have the largest stock of modular stainless steel products in the country. However, sometimes we get fooled by spikes in demand (this is a fancy way of saying that we either made a mistake or a customer ran us out of something). But we re-order quickly and can still get products to you faster than most local fabricators - and loads cheaper of course.

Need More Info?

We now have even more useful videos for assembly and information on Brayco products. Scan to view.



Did You Know?

Brayco's chrome and epoxy wire shelving is **15% thicker** compared to other competing brands.

Here are 4 factors that make selecting Brayco wire shelving a smart choice:

Increased Load Capacity

Brayco wire shelving supports heavier loads without sagging or bending.

Longer Lifespan

Thicker units are less likely to wear down or become misshapen over time.

More Stable

Thicker and stronger shelving has less risk of wobbling or shifting - crucial for maintaining the safety of stored items and preventing accidents.

Professional Appearance

Thicker wire shelving can give your storage area a more professional and organized appearance, perfect for spaces where aesthetics matter.

View the full range on page 16 & 17.



15% THICKER
Compare the quality!



Eco Friendly

Brayco Stainless Steel is made from 95% recycled materials.

Wall Shelves



450mm deep shelf
Code: SHSS9045



450mm corner shelf
Code: SHSSC45



Pipe Shelves

- Above sink drainage.
- Perfect to hang items from.
- Great for pots.



300mm Deep

Code	Length (mm)	PRICE*
PIPE6030	600	\$94
PIPE9030	900	\$104
PIPE12030	1200	\$124
PIPE15030	1500	\$144
PIPE18030	1800	\$179
PIPE20030	2000	\$219
PIPE24030	2400	\$239

450mm Deep

Code	Length (mm)	PRICE*
PIPE6045	600	\$124
PIPE9045	900	\$139
PIPE12045	1200	\$169
PIPE15045	1500	\$199
PIPE18045	1800	\$229
PIPE20045	2000	\$239
PIPE24045	2400	\$264

Flat Wall Shelves

Add extra storage to your room.

300mm Deep

- Create more workspace by adding wall storage.

Code	Length (mm)	PRICE*
SHSS4030	400	\$79
SHSS6030	600	\$84
SHSS9030	900	\$104
SHSS12030	1200	\$124
SHSS15030	1500	\$149
SHSS18030	1800	\$169
SHSS20030	2000	\$199
SHSS24030	2400	\$234
Corner Shelf: SHSSC30		\$129

500 (L) x 300 (D) x 285 front

450mm Deep

- Terrific for microwaves.
- Extra deep.

Code	Length (mm)	PRICE*
SHSS4045	400	\$124
SHSS6045	600	\$149
SHSS9045	900	\$159
SHSS12045	1200	\$179
SHSS15045	1500	\$199
SHSS18045	1800	\$239
SHSS20045	2000	\$269
SHSS24030	2400	\$289
Corner Shelf: SHSSC45		\$144

650 (L) x 450 (D) x 285 front

4-Tier Stainless Steel Shelf

A very popular item, when only stainless steel will do.

- 2 fixed shelves.
- Adjustable feet.
- 1800mm high.
- Shelves are 430 grade steel.
- Weight rating 50kg even load per shelf.



Code	Length	Depth	PRICE*
SHSS4T9	900	510	\$489
SHSS4T12	1200	510	\$569
SHSS4T15	1500	510	\$659

Wall Shelf Side Panel

- Set of 2.
- Enclose the two ends of your flat wall shelves.



Code: SHSS45SPX2 \$12
To fit 450mm deep

Code: SHSS30SPX2 \$12
To fit 300mm deep

2 Tier Overshelves

Convenient over bench storage.

- Sits on top of benches or cabinets.
- Extra shelves available.
- Legs can be cut down to reduce the height.



Shelf height can be adjusted.

Legs can be cut down to suit your use.

Code	Length (mm)	PRICE*	EXTRA SHELF
SH2T550	550	\$229	\$74
SH2T850	850	\$254	\$89
SH2T1150	1150	\$284	\$99
SH2T1450	1450	\$319	\$129
SH2T1750	1750	\$344	\$149



- Top shelf is 350mm deep.
- Adjustable middle shelf is 275mm deep.
- 800mm high.

"I was looked after with some good old fashioned customer service by a very helpful, knowledgeable and keen to please Alain. These days that sort of service is rare - thanks for a job well done!"

Geoff

*Prices include GST. Prices vary due to raw material and exchange rate fluctuations and are subject to change without notice.

Flat Benches

from **\$179**

When you buy from us, you are buying directly from the importer.

No distributors. No middlemen. We keep overheads down and we price the products accordingly.



Compare the quality. 304 Grade Stainless Steel



Code: 3036 \$374
914 (L) x 762mm (D)

304 Grade

The industry standard stainless steel grade. It is highly resistant to corrosion. We use 1.2mm thick stainless steel which is 20% thicker than some benches on the market. Legs are stainless steel. Undershelves are galvanised.

Adjustable Shelf

Each bench comes with a high quality 1.2mm galvanised undershelf, this thickness is vital to stability. Fully height adjustable.

Flatpack

Benches are supplied flat packed for ease-of-handling and to lower freight costs. It takes about 15 mins to assemble a bench with the supplied allen key and screws.

Feet or Castors

Benches are supplied with feet that screw out an extra 18mm. Upgrade to screw your benches to the floor with screw in feet and legs or add lockable castors for a mobile bench.

	Code	Length (mm)	Depth (mm)	Height (mm)	PRICE*	
450 DEEP	6045	600	450	900	\$244	
	8045	800	450	900	\$264	
	9045	900	450	900	\$284	
	12045	1200	450	900	\$339	
	15045	1500	450	900	\$399	
457 DEEP	18045	1800	450	900	\$464	
	1824	610	457	900	\$209	
	1830	762	457	900	\$229	
610 DEEP	1836	914	457	900	\$264	
	2424	610	610	900	\$234	
	2436	914	610	900	\$349	
	2448	1219	610	900	\$399	
	2460	1524	610	900	\$504	
	2472	1829	610	900	\$549	
	2484**	2134	610	900	\$684	
	2496**	2438	610	900	\$714	
762 DEEP	3030	762	762	900	\$339	
	3036	914	762	900	\$374	
	3048	1219	762	900	\$444	
	3060	1524	762	900	\$529	
	3072	1829	762	900	\$619	
	3084**	2134	762	900	\$714	
	3096**	2438	762	900	\$789	
	914 DEEP	3636	914	914	900	\$504
		3648	1219	914	900	\$569
		3660	1524	914	900	\$714
3672**		1829	914	900	\$854	
3684**		2134	914	900	\$939	
3696**		2438	914	900	\$999	

** These benches have 6 legs.

Folding Benches

- Popular choice for pop up markets.
- Easy to fold leg
- Adjustable feet
- 304 grade top.
- 304 grade legs.



Code	Length (mm)	Depth (mm)	Height (mm)	PRICE*
2460 Fold	1524	610	900	\$634
2472 Fold	1829	610	900	\$699

ECONOMY RANGE.

Same features as above but with an economy 430 grade top.

ECO1200FOLD	1200	610	900	\$339
-------------	------	-----	-----	-------

*Prices include GST. Prices vary due to raw material and exchange rate fluctuations and are subject to change without notice.

MODULAR
Sinks, Cabinets & Benches



Code: 3096 \$789
2438 (L) x 762mm (D)

ECONOMY RANGE

610mm & 700mm benches

Welcome to the all new range of economy priced flat top benches. Now you can choose food grade 304 or the economically priced 430 range listed below.

- 430 grade top
- galvanised undershelf
- Galvanised legs

	Code	Length (mm)	Depth (mm)	Height (mm)	PRICE*
610 DEEP	ECO6061	600	610	900	\$179
	ECO9061	900	610	900	\$219
	ECO12061	1200	610	900	\$279
	ECO16061	1600	610	900	\$319
	ECO18061	1800	610	900	\$344
700 DEEP	ECO6070	600	700	900	\$189
	ECO9070	900	700	900	\$229
	ECO12070	1200	700	900	\$289
	ECO16070	1600	700	900	\$344
	ECO18070	1800	700	900	\$374

UPGRADE:

Stainless Steel Undershelf

See Leg Options Panel (next page)

PLUS:

Screw down feet and galvanised legs

Set of 2 - \$50 Code: GFEE2

304 VS 430 Grade Steel

Brayco's 304 grade stainless steel benches are the ultimate choice for an impervious food preparation surface that is durable and hygienic.

This high-quality steel is the preferred choice for professionals in the catering industry.

For budget-conscious users, 430 grade stainless steel benches are an excellent choice. While they are still highly durable, they may exhibit slightly less resistance to corrosion compared to the 304 grade, making them a practical and cost-effective option for non-commercial applications.

Flat Benches and Accessories

Extra Leg Options

All benches are supplied with stainless steel legs and height adjustable feet. We offer you options to upgrade to suit your requirements.

Screw down feet and stainless steel legs



Set of 2 - \$59 Code: SFEETCDX
Screw down feet with high grade stainless steel legs, recommended for extremely salty or chemical conditions.

Set of 2 - \$79 Code: SFEET2

High quality heavy duty lockable castors with stainless steel legs.



Set of 2 - \$74 Code: WHEELSSCDX
High quality heavy duty lockable castors with high grade stainless steel legs.

Set of 2 - \$89 Code: WHEELSS2

High grade stainless steel legs & feet

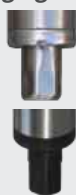

Recommended for use in extremely salty or chemical conditions or for that extra sparkle. Adjustable feet Set of 2 - \$59 Code: SLEGS2

Need an extra legs or to replace old legs? (They are the same stainless steel legs with adjustable feet that are supplied with each bench)

Set of 2 - \$34 Code: SLEGS2CDX

** Benches with 6 legs will require 3 sets of legs. All other benches require 2 sets of legs.

Shorter or longer legs

Brayco now offer a leg cutting service & can supply longer legs should you require a different height of your bench or sink.

Leg cutting service to shorten legs:

Code: CUT-SL \$70 per set of 2 legs

Supply longer legs to make your bench or sink higher:

Code: CUT-LL \$100 per set of 2 legs

Enclose Your Bench

Attach panels (wood, mdf, acrylic) to bench legs so you can enclose the under space. Great for turning a simple bench into a stylish cabinet.

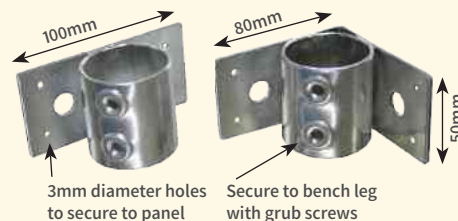

Here's how Leg Attachments convert a stainless steel bench to an enclosed a mobile coffeecart.

Code	Attachment	PRICE*
LEGATTS	Straight leg	\$12
LEGATTC	Corner leg	\$12



DRS \$244

DRS60 \$264

DRD2 \$409

DRD \$454

Lockable Drawers

Key lockable drawer units can be added to most of our benches for a quick, cost effective storage solution.

Code	Length (mm)	Depth (mm)	Height (mm)	Drawers	PRICE*
DRS	520	450	150	1	\$244
DRS60*	670	450	180	1	\$269
DRD2	520	450	365	2	\$409
DRD	525	450	480	2	\$454

- Inside drawer measures 420 x 420mm.
 - Key lockable drawers.
 - Fits 610mm deep and above benches with minimum of 600mm width between legs.
- *DRS60: min. 700mm width
NB: measurements include external brackets.

Upgrade Your Undershell

Replace the standard galvanised shelf supplied with your bench with a stainless shelf. Recommended for extremely salty or chemical conditions - or if you want that extra sparkle.

EXAMPLE : To upgrade a bench code 2436 (normal price \$349) - you can get just the stainless steel undershell (see right - add \$104) and/or high grade stainless steel legs (see above - add 2 sets \$59 X 2). Total : \$571

Bench Code	Upgrade PRICE*	Bench Code	Upgrade PRICE*	Bench Code	Upgrade PRICE*	Bench Code	Upgrade PRICE*	Bench Code	Upgrade PRICE*	Bench Code	Upgrade PRICE*
6045	\$69	1830	\$84	2484	\$214	3084	\$244	3696	\$324	ECO9070	\$94
8045	\$79	1836	\$89	2496	\$234	3096	\$259	ECO6061	\$64	ECO12070	\$134
9045	\$89	2424	\$89	3030	\$99	3636	\$144	ECO9061	\$79	ECO16070	\$179
12045	\$99	2436	\$104	3036	\$119	3648	\$174	ECO12061	\$99	ECO18070	\$199
15045	\$114	2448	\$124	3048	\$134	3660	\$219	ECO16061	\$119		
18045	\$134	2460	\$154	3060	\$174	3672	\$249	ECO18061	\$129		
1824	\$74	2472	\$179	3072	\$199	3684	\$299	ECO6070	\$89		

Shelf Options For Your Bench

Replace Your Shelf With a Leg Brace Rail Kit

Remove your shelf and add leg brace rail kits for extra strength & stability.

These stainless steel rails can be fixed anywhere on the front, back & sides of bench legs. Rails are designed to support your bench when removing the undershell to allow for extra storage room such as a dishwasher, washing machine etc. Rails are sold as kits but you can also ask for individual component prices.



Rails can be fixed at any height.
Remove front rail to fit a fridgetor dishwasher underneath.



Need to know more?
Scan for more information

Kit prices are listed for each bench. Each kit contains:

- 2 x side rails,
- 1 x front rail,
- 1 x back rail,
- 6 x height adjustable connectors.

We can customise a kit for you. Please call for advice.

3 Way Attachment Available to purchase separately \$14 each

Bench Code	Upgrade PRICE*	Bench Code	Upgrade PRICE*	Bench Code	Upgrade PRICE*	Bench Code	Upgrade PRICE*	Bench Code	Upgrade PRICE*	Bench Code	Upgrade PRICE*
6045	\$127	1830	\$129	2484	\$270	3084	\$274	3696	\$296	ECO9070	\$149
8045	\$130	1836	\$130	2496	\$290	3096	\$294	ECO6061	\$137	ECO12070	\$142
9045	\$130	2424	\$130	3030	\$134	3636	\$136	ECO9061	\$150	ECO16070	\$153
12045	\$138	2436	\$133	3036	\$135	3648	\$148	ECO12061	\$142	ECO18070	\$158
15045	\$145	2448	\$145	3048	\$147	3660	\$153	ECO16061	\$165		
18045	\$154	2460	\$150	3060	\$152	3672	\$258	ECO18061	\$167		
1824	\$127	2472	\$155	3072	\$157	3684	\$276	ECO6070	\$131		

Splashback Benches, 450, 610 or 700mm deep

from **\$199**

New Zealand's largest range of flat and splashback 304 grade stainless steel benches.

Commercial grade. Ready for a day's work.



Largest range in New Zealand.



Code: 12070SP \$489
1200 (L) x 700mm (D)

304 Grade

The industry standard stainless steel grade. It is highly resistant to corrosion. We use 1.2mm thick stainless steel which is 20% thicker than some benches on the market. Legs are stainless steel. Undershelves are galvanised.

Adjustable Shelf

Each bench comes with a high quality 1.2mm galvanised undershelf - this thickness is vital to stability - fully height adjustable. See opposite page to upgrade to stainless steel.

Flatpack

Benches are supplied to you flat packed with an allen key & screws. Simple assembly.

Screw Down Feet And Legs

Benches are supplied with feet that screw out an extra 18mm. Upgrade to screw your benches to the floor with screw down feet and legs.

MODULAR
Sinks, Cabinets & Benches

Sinks & Cabinets to Match

700mm deep splashback benches are completely modular with 700mm deep sinks, cabinets and benches.

450mm Splashback

50mm high splashback
40mm deep splashback

Code	Length (mm)	Depth (mm)	Height (mm)	PRICE*
12045SP	1200	450	900	\$379
15045SP	1500	450	900	\$454
18045SP	1800	450	900	\$474
CU450	450	450	900	\$409

UPGRADE OPTIONS:

See Leg Options Panel (bottom panel)
Stainless Steel Undershelf

610mm Splashback

150mm high splashback
20mm deep splashback

Code	Length (mm)	Depth (mm)	Height (mm)	PRICE*
3061SP	300	610	900	\$219
4061SP	400	610	900	\$239
6061SP	600	610	900	\$289
8061SP	800	610	900	\$329
9061SP	900	610	900	\$349
10061SP	1000	610	900	\$374
12061SP	1200	610	900	\$399
15061SP	1500	610	900	\$519
16061SP	1600	610	900	\$549
18061SP	1800	610	900	\$599
20061SP	2000	610	900	\$644
22061SP**	2200	610	900	\$714
24061SP**	2400	610	900	\$764
CU61LGE	810	810	900	\$529

UPGRADE OPTIONS:

See Leg Options Panel (bottom panel)
Stainless Steel Undershelf



Corner Bench
Code: CU450 \$409
Suits 450mm benches



Corner Bench
Code: CUSML \$494
Suits 700mm benches



Corner Bench
Code: CULGE \$654
Suits 700mm benches



Corner Bench
Code: CU61LGE \$529
Suits 610mm benches

Leg Options



All benches are supplied with stainless steel legs and height adjustable feet. We offer you options to upgrade to suit your requirements.



High grade stainless steel legs & feet
Recommended for use in extremely salty or chemical conditions or for that extra sparkle.
Set of 2 - \$59 Code: SLEGS2



Set of 2 - \$49 Code: GFEE2
Screw down feet with galvanised steel legs
Set of 2 - \$59 Code: SFEETCDX
Screw down feet with high grade stainless legs, recommended for extremely salty or chemical conditions.
Set of 2 - \$79 Code: SFEET2

** These benches have 6 legs and will need 3 sets of legs. All other tables require 2 sets of legs.

700mm Splashback

150mm high splashback
40mm deep splashback

Code	Length (mm)	Depth (mm)	Height (mm)	PRICE*
3070SP	300	700	900	\$229
4070SP	400	700	900	\$279
6070SP	600	700	900	\$324
8070SP	800	700	900	\$379
9070SP	900	700	900	\$399
10070SP	1000	700	900	\$439
12070SP	1200	700	900	\$489
15070SP	1500	700	900	\$604
16070SP	1600	700	900	\$629
18070SP	1800	700	900	\$679
20070SP	2000	700	900	\$739
22070SP**	2200	700	900	\$809
24070SP**	2400	700	900	\$884
Corner CUSML	700	700	900	\$494
Corner CULGE	900	900	900	\$654
WCBH700	600	700	900	\$519

UPGRADE OPTIONS:

See Leg Options Panel (bottom panel)
Splashback Extension, Stainless Steel Undershelf



Waste Collection Bench

Fully welded hole - strong and durable.
300mm diameter hole
600 (L) x 700 (D) x 900mm (H)
Code: WCBH700 \$519

ECONOMY RANGE

610mm & 700mm splashback

- 430 grade top
- Galvanised undershelf
- Galvanised legs
- 150mm high splashback
- 610mm deep: 20mm deep splashback
- 700mm deep: 40mm deep splashback

	Code	Length (mm)	Depth (mm)	Height (mm)	Price*
610 DEEP	ECO6061SP	600	610	900	\$199
	ECO9061SP	900	610	900	\$249
	ECO12061SP	1200	610	900	\$309
700 DEEP	ECO6070SP	600	700	900	\$219
	ECO9070SP	900	700	900	\$264
	ECO12070SP	1200	700	900	\$319

UPGRADE OPTIONS:

See Leg Options Panel (bottom panel)



Code: P2400 \$949
2400 (L) x 610mm (D)

610mm Splashback (150mm high splashback)

Code	Length (mm)	Depth (mm)	Height (mm)	PRICE*
P400	400	610	900	\$329
P600	600	610	900	\$389
P800	800	610	900	\$434
P900	900	610	900	\$464
P1000	1000	610	900	\$484
P1200	1200	610	900	\$549
P1400	1400	610	900	\$599
P1500	1500	610	900	\$634
P1600	1600	610	900	\$659
P1800	1800	610	900	\$714
P2000	2000	610	900	\$799
P2200	2200	610	900	\$909
P2400	2400	610	900	\$949
PCU	810	810	900	\$549



Corner Bench Code: PCU \$549
Corner edges: 810 x 810mm, fits 610mm bench

Splashback Extensions

Suitable for Sinks, Benches & Cabinets

Add a stainless steel splashback extension to convert your sink or bench to a corner unit. Fits on the left hand or right hand side of a bench.

Code	To Fit	Length	PRICE*
CSB600	Full Range	600mm	\$54
CSB610	610 Range	590mm	\$49
CSB700	700 Range	660mm	\$59
CSB900	Full Range	900mm	\$64
CSB1000	Full Range	1000mm	\$69

Splashback Extension Available
CSB610 fits a 610mm deep bench

Jam-packed with quality upgrades – at surprisingly low prices.



Fully Stainless
All benches are fully stainless, but keenly priced. The legs are stainless, the undershelves are stainless.



Extra Strong
We've added an extra support bar and square leg construction. The result? Benches that could repel an army invasion!

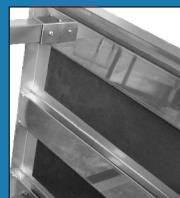

Noise Reduction
We've lined the underside with a polymer layer that reduces noise by a huge amount. Kitchens can be noisy but not with our benches.

10 Matching Sinks & 9 Other Matching Benches

We've expanded our range of matching sinks and the PREMIUM 610mm range also matches 610mm flat benches and cabinets. Truly thousands of layout options.

Shelf Options For Your Bench

Upgrade your galvanised undershelf to stainless steel. Recommended for extremely salty or chemical locations. Or if you want that extra sparkle.

Bench Code	Upgrade PRICE*	Bench Code	Upgrade PRICE*	Bench Code	Upgrade PRICE*
3070SP	\$56	12045SP	\$99	22061SP	\$159
4070SP	\$69	15045SP	\$114	24061SP	\$169
6070SP	\$89	18045SP	\$134	CU61SP	\$114
8070SP	\$103	CU450	\$119	ECO6061SP	\$64
9070SP	\$94	3061SP	\$54	ECO9061SP	\$79
10070SP	\$119	4061SP	\$56	ECO12061SP	\$99
12070SP	\$134	6061SP	\$64	ECO6070SP	\$89
15070SP	\$174	8061SP	\$74	ECO9070SP	\$94
16070SP	\$179	9061SP	\$79	ECO12070SP	\$134
18070SP	\$199	10061SP	\$84		
20070SP	\$219	12061SP	\$99		
22070SP	\$246	15061SP	\$114		
24070SP	\$264	16061SP	\$119		
CUSML	\$149	18061SP	\$129		
CULGE	\$169	20061SP	\$144		

Leg Brace Rail Kit

Need room for a fridge, dishwasher or more? See page 5 for more info.



Bench Code	Upgrade PRICE*	Bench Code	Upgrade PRICE*	Bench Code	Upgrade PRICE*
3070SP	\$99	12045SP	\$119	24061SP	\$244
4070SP	\$109	15045SP	\$124	CU61SP	\$119
6070SP	\$114	18045SP	\$124	ECO6061SP	\$137
8070SP	\$124	3061SP	\$99	ECO9061SP	\$150
9070SP	\$124	4061SP	\$109	ECO12061SP	\$142
10070SP	\$124	6061SP	\$114	ECO6070SP	\$131
12070SP	\$129	8061SP	\$124	ECO9070SP	\$149
15070SP	\$134	9061SP	\$124	ECO12070SP	\$142
16070SP	\$139	10061SP	\$124		
18070SP	\$139	12061SP	\$129		
20070SP	\$144	15061SP	\$134		
22070SP	\$224	16061SP	\$139		
24070SP	\$244	18061SP	\$139		
CUSML	\$119	20061SP	\$144		
CULGE	\$119	22061SP	\$224		



Sinks

from **\$624**

Why are commercial sinks so expensive?

We have absolutely no idea!

MODULAR
Sinks, Cabinets & Benches

Construction

Our very sturdy sinks are fully stainless steel, even the screws.

Bowls

All bowls are 300mm deep and mostly 500mm long by 450mm wide, some variations. Fully welded & STRONG

Tap Location

There is room between the sink and the splashback, through the actual splashback or you can even mount taps from your wall.

Splashback

700mm and 610mm sinks come with a splashback height of 150mm. The 450mm sink features a more compact 50mm splashback. All sink splashbacks are designed to align with the splashback benches.

Sink Drainer

Sink drainer are supplied with every sink.



Also available to purchase separately at \$24 each.

BD \$24

Waster Drainer

Fixed Strainer with a removable basket and plug.

Easy to assemble. Can be retro fitted to 90mm outlet.

SSBW \$229



Tap Hole Cutting Service

A 35mm TAP HOLE CUTTING service available on request. Code: CUT-H \$50 per hole



Code: DSM \$1044

1300 (L) x 700mm (D)
Double bowls:
450 (L) x 450 (D) x 300mm (H)

700mm Deep Sinks

Match 700mm Benches, & Cabinets

Code	Length (mm)	Depth (mm)	Height (mm)	Bowls	Bowl Literage	PRICE*
SSN	665	700	900	1	67L	\$654
STN	850	700	900	1	157L	\$779
SSL	1350	700	900	1	67L	\$874
SSR	1350	700	900	1	67L	\$874
SSRL1500	1500	700	900	1	67L	\$939
SSRL	1800	700	900	1	54L	\$1189
SSRLTROUGH	1800	700	900	1 Trough	94L	\$1189
DSM	1300	700	900	2	60L ea	\$1044
DSR1500	1500	700	900	2	67L ea	\$1099
DSL1500	1500	700	900	2	67L ea	\$1099
DSL17	1700	700	900	2	54L ea	\$1149
DSR17	1700	700	900	2	54L ea	\$1149
SSR1800	1800	700	900	1	67L ea	\$999
SSL1800	1800	700	900	1	67L ea	\$999
DSR	1900	700	900	2	67L ea	\$1254
DSL	1900	700	900	2	67L ea	\$1254
DSRL2000	2000	700	900	2	67L ea	\$1369
DSR2200HB	2200	700	900	3	67L ea	\$1664
DSRL	2590	700	900	2	67L ea	\$1564
TSRL	2590	700	900	3	67L ea	\$1964

Screw Down Feet

Your option to upgrade your standard adjustable feet.



Easy to assemble. Just push it in! Set of 4.

SFEETONLYX4 \$56

Sink Bracket

Secure your sink to the wall.

Set of 2 (per leg). BRAC-SINKWALL \$12



Underbench Sink Shelves

Add extra storage by attaching an underbench sink shelf onto the support bar of your sink. These must be assembled with your sink. Do not clip on.



To fit 700mm deep sink

Shelfsink700 580 x 650 \$119

To fit 610mm deep sink

Shelfsink610 485 x 650 \$104

610mm Deep Sinks

Match 610mm Benches, & Cabinets

Code	Length (mm)	Depth (mm)	Height (mm)	Bowls	Bowl Literage	PRICE*
SSN610	665	610	900	1	60L	\$624
DSM610	1000	610	900	2	48L ea	\$884
SSR610-10	1000	610	900	1	60L	\$749
SSL610-10	1000	610	900	1	60L	\$749
SSR610-12	1200	610	900	1	60L	\$799
SSL610-12	1200	610	900	1	60L	\$799
SSR610	1350	610	900	1	60L	\$809
SSL610	1350	610	900	1	60L	\$809
DSR610-15	1500	610	900	2	60L ea	\$999
DSL610-15	1500	610	900	2	60L ea	\$999
SSRL610-15	1500	610	900	1	60L	\$849
SSRL610	1800	610	900	1	60L	\$949
SSR610-18	1800	610	900	1	60L	\$949
SSL610-18	1800	610	900	1	60L	\$949
DSR610	1900	610	900	2	60L ea	\$1159
DSL610	1900	610	900	2	60L ea	\$1159
DSRL610-20	2000	610	900	2	60L ea	\$1194
DSRL610-24	2400	610	900	2	60L ea	\$1329

450mm Deep Sink

Match 450mm Benches

Code	Length (mm)	Depth (mm)	Height (mm)	Bowls	Bowl Literage	PRICE*
SSN450	665	450	900	1	43L	\$539



Splashback Extension

Add a stainless steel splashback extension to convert your sink to a corner unit.



Code	Length (mm)	PRICE*
CSB600	600	\$54
CSB610	590	\$49
CSB700	660	\$59
CSB900	900	\$64
CSB1000	1000	\$69

*Prices include GST. Prices vary due to raw material and exchange rate fluctuations and are subject to change without notice.

from **\$129**

Inset Sinks

- High quality 304 grade stainless steel.
- Fully welded.
- Size listed right is of the actual bowl.
- All sinks have a 20mm lip.
- Suitable for over-mount.
- 90mm strainer waste and plug included.
- 15, 18 & 40 Litre bowls are 1mm steel. 60, 67 & 94 Litre bowls are 1.2mm.



*80mm Tap Lip

Code	Length (mm)	Depth (mm)	Height (mm)	Bowl Litrage	PRICE*
INS3025	300	250	200	15L	\$149
INS3025TL*	300	250	200	15L	\$149
INS3030	300	300	200	18L	\$154
INS3530	355	305	170	18L	\$149
INS3530TL*	355	305	170	18L	\$149
INS5030	500	300	250	37.5L	\$184
INS4530	450	300	300	40L	\$189
INS4545	450	450	300	60L	\$269
INS4050	500	400	300	60L	\$264
INS5045	500	450	300	67L	\$279
INS7045	700	450	300	94L	\$329

Sink Covers

Create extra workspace with a stainless steel sink cover.



Code	Description	Length (mm)	Depth (mm)	To Fit Sink	PRICE*
SCB400	Sink Cover – Flat	540	440	610mm Sink#	\$74
SCH400	Sink Cover – Slats	535	360	610mm Sink#	\$64
SCB500	Sink Cover – Flat	540	490	700mm Sink##	\$84
SCH500	Sink Cover – Slats	530	410	700mm Sink##	\$74

#This sink cover will fit the following 610mm sink units:
SSN610, SSR610-10, SSL610-10, SSR610-12, SSL610-12, SSR610, SSL610, DSR610-15, DSL610-15, SSRL610-15, SSRL610, SSR610-18, SSL610-18, DSR610, DSL610, DSRL610-20, DSRL610-24, DISHINL, DISHINR, DISHINL-12, DISHINR-12, DDISHINL, DDISHINR & INS4050.

##This sink cover will fit the following 700mm sink units:
DSR, DSL, SSN, DSRL, TSRL, DSR1500, DSL1500, SSR1800, SSL1800, DSRL2000, DSR2200HB, SSRL1500, SSL, SSR & INS5045.

Pipe Undershelves

Add a pipe shelf to your sink



Sink Code	Upgrade PRICE*	Sink Code	Upgrade PRICE*	Sink Code	Upgrade PRICE*
SSN450	\$69	SSR610	\$99	SSRL1500	\$124
SSN610	\$84	SSL610	\$99	SSRL	\$134
DSM610	\$99	SSRL610	\$124	SSRLTROUGH	\$134
SSR610-10	\$99	SSN	\$89	DSM	\$114
SSL610-10	\$99	STN	\$94	DSR17	\$129
SSR610-12	\$99	SSR	\$114	TSRL(half shelf)	\$104
SSL610-12	\$99	SSL	\$114		

hands free



Push Panel



tap Included

Knee Operated Handbasin

Code: KB \$1149

Outer size 432 x 380 x 285mm high, 50mm splashback.

Bowl size 356 x 254 x 140mm deep.

Bowl holds 13 litres.

Sink waste drainer included.

Comes complete with WELS approved plumbing hardware.

Completely 304 grade stainless steel.



Corner Handbasin

Code: HBC \$104

Outer size 265 x 265 x 165mm high, 25mm splashback.

Bowl size 230mm diameter x 120mm deep.

Bowl holds 2.5 litres.



Handbasin

Code: HB \$159

Outer size 430 x 380mm, 50mm splashback.

Bowl size 350 x 250 x 150mm deep.

Overall height 200mm high.

Bowl holds 13 litres.



Mop Sink

Code: Mop Sink \$459

Outer size 610 x 530mm, 25mm splashback.

Bowl size 500 x 400 x 250mm deep.

Bowl holds 50 litres.

Wall bracket 474mm high.



Cleaners Sink

Code: Cleaners Sink \$494

Outer size 610 x 530mm, 25mm splashback.

Bowl size 500 x 400 x 240mm deep.

Bowl holds 50 litres.

Wall bracket 480mm high.

Screw down feet.

Wall Mounted Sinks

Hygienic sinks at surprisingly low prices.

from **\$104**

Same high grade stainless steel as our freestanding sinks - no shortcuts here. Wall brackets and sink drainer included.

Code	Length (mm)	Depth (mm)	Height inc bracket	Bowls	Bowl Litrage	PRICE*
HBC (Corner Sink)	265	265	165	1	2.5L	\$104
HB	430	380	200	1	13L	\$159
Mop Sink	610	530	474	1	50L	\$459
Cleaners Sink	610	530	600	1	50L	\$494
KB (Knee Operated)	432	380	285	1	13L	\$1149

Dishwasher Inlet & Outlet Benches

from **\$454**

INLET /
Left to right

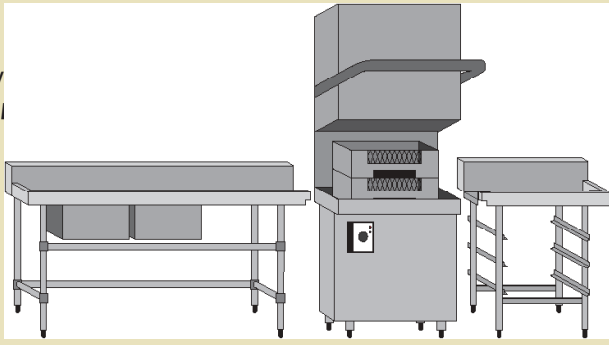

Inlet Bench:
DISHINL
DDISHINL

Outlet Bench:
DISHOUTR
DISHOUTSHR

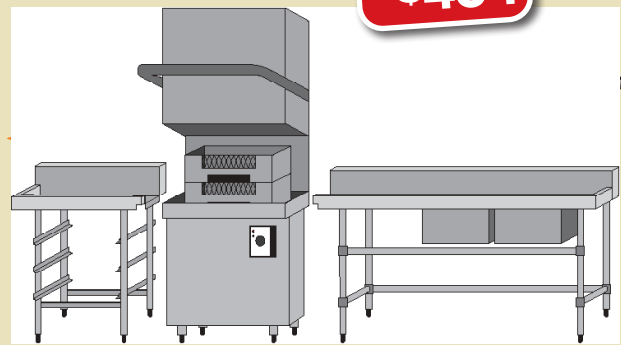

Outlet Bench:
DISHOUTL
DISHOUTSHL

Inlet Bench:
DISHINR
DDISHINR

Sinks and benches designed to attach to the side of your dishwasher.

Construction

The legs, bowls and screws are all stainless steel.
Very sturdy.
Available in left or right configurations.

Splashback

Each sink has a 150mm high splashback.



Left or Right Configuration

Lip allows dish racks to slide easily in & out of your dishwasher.



Tap Location

There is room between the sink and the splashback, through the actual splashback or you can even mount a tap on the wall.

Modular

Matches the 700mm deep range of benches and cabinets.



Outlet Benches

Benches with 130mm (D) x 150mm (H) splashback



Code: DISHOUTSHL
\$564 Right opening



Code: DISHOUTL
\$454 Right opening

DISHOUTSHL, DISHOUTSHR
3 sets of shelf sliders for dish racks.
Strong, square legs.
Dish racks available, see left.

DISHOUTL, DISHOUTR
Adjustable galvanised undershelf

Code	Length (mm)	Depth (mm)	Height (mm)	Lip Location	PRICE*
DISHOUTL	800	700	900	on right	\$454
DISHOUTR	800	700	900	on left	\$454
DISHOUTSHL	800	700	900	on right	\$564
DISHOUTSHR	800	700	900	on left	\$564

Stainless Undershelves

Replace standard galvanised shelf

Sink Code	Upgrade PRICE*
DISHOUTL	\$99
DISHOUTR	\$99

Pipe Undershelves

Add a pipe shelf to your outlet sink

Sink Code	Upgrade PRICE*
DISHOUTL	\$99
DISHOUTR	\$99

Inlet Sinks

Sinks with 130mm (D) x 150mm (H) splashback



Code: DISHINL
\$1284 Right opening



Code: DDISHINL
\$1569 Right opening

Code	Length (mm)	Depth (mm)	Height (mm)	Bowl	flat edge	PRICE*
DISHINL	1800	700	900	1 (58L)	on right	\$1284
DISHINR	1800	700	900	1 (58L)	on left	\$1284
DDISHINL	1800	700	900	2 (58L ea)	on right	\$1569
DDISHINR	1800	700	900	2 (58L ea)	on left	\$1569

Pipe Undershelves

Add a pipe shelf to your dishwasher inlet sink

Sink Code	Upgrade PRICE*	Sink Code	Upgrade PRICE*
DISHINL	\$109	DDISHINL	\$109
DISHINR	\$109	DDISHINR	\$109

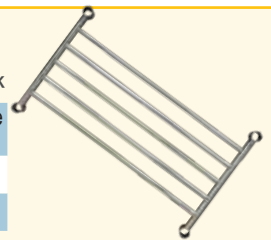

"I have to say that this would have to be one of the best and most professional services that I've dealt with in a long time. Incredibly efficient with excellent communication. I'll fully recommend your business to anyone that wants to listen. A big thank you." Scott

*Prices include GST. Prices vary due to raw material and exchange rate fluctuations and are subject to change without notice.

"My tap arrived very quickly and I'm very pleased with it. I'm just writing to thank you for your terrific customer service. Have a good day." Fiona

- WELS 4 Star 7.5 litres per minute
- Watermark certified
- DR brass body, zinc alloy handle
- Nickel and chrome finish
- Replaceable ceramic cartridge

Durable, attractive taps to go with every sink. One-stop shopping!



Handsfree Basin Mixers

Ideal for hospitals and aged care. An ideal choice for hygienic hand washing and a must for the Brayco wall mounted sinks. 12 months warranty.



\$139

Handsfree Sink Mixer
Code: **HANDFBM**



Extended lever

\$159

Handsfree Sink Mixer
• Swivel spout.
Code: **HANDFKM**

Basin Mixers

Sink mixers with swivel outlet. 12 months warranty.



\$199

AXIL Kitchen Mixer
• Swivel spout.
Code: **KITMIX**



\$239

AXIL Goose Neck Kitchen Mixer
• Swivel spout.
Code: **GOKITMIX**

Flexible Pull Down Kitchen Mixer Taps

- Fully flexible metal pull-down hose for longevity
- Swivel functionality for full sink access.



Jet/spray nozzle



Jet/spray nozzle



\$399

Jet & Spray Nozzle
Code: **POKITMIX**

AXIL Pull Out Kitchen Mixer

- Overall height of 410mm.
- Variable nozzle with jet and spray output.
- Swivel spout.
- 12 months warranty.
- Replacement hose **\$39**
- Replacement head **\$59**



Jet/spray nozzle
VT Models only

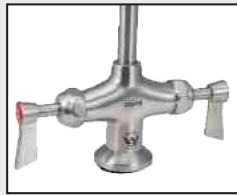

Hot & cold taps



Swivel pot filler



\$1,499

Jet & Spray Nozzle
Code: **VT-TSPRAY**

Pre Rinse Unit

- Overall height of 550mm.
- Variable nozzle - jet and spray output (shown above).
- Optional wall bracket included.
- 2 year warranty.



\$1,999

Jet & Spray Nozzle
Code: **VT-TSPRAYPF**

Pre Rinse Unit/Pot Filler

- Overall height of 580mm
- 12" pot filler tap
- Variable nozzle - jet and spray output (shown above).
- Optional wall bracket included.
- 2 year warranty.



Wall bracket

\$2,199

Jet & Spray Nozzle
Code: **VT-TSPRAYPFL**

Pre Rinse Unit/Pot Filler

- Overall height of 1040mm.
- Wall fixing for strong support.
- 12" pot filler tap.
- Variable nozzle - jet and spray output.
- 2 year warranty.

Cabinets

Construction

Food-grade 304 stainless steel top with reinforced lining. Sides and internals are 430 grade.



Internal Shelf

All cabinets are supplied with an adjustable internal shelf.

Outdoor Grade

If you have a largely covered area, then the indoor grade cabinets are suitable. However, if your cabinet will be exposed to the elements we offer outdoor grade options. For information, please call your branch on 09 271 5000.



Castors or Feet?

Cabinets are fitted with braked castors or height adjustable feet. Your choice. No extra charge. They are attached by a thick steel plate with 4 bolts. Super strong.



Code: CAB12070

1200 (L) x 700mm (D) \$1509
Adjustable internal shelf.

No drawers but more internal space. Shown with lockable castors.



CABBQ10070 and CABBQ16070 have rear vent and hole.

ABOVE: Code: CABBQ10070
1000 (L) x 700mm (D) \$1599

700mm Deep Cabinets to match 700mm Benches & Sinks

- Choose feet or castors for a mobile cabinet.
- Adjustable internal shelf.

Code	Length (mm)	Depth (mm)	Height (mm)	Drawers	PRICE*
NEW CABBQ10070	1000	700	900	3	\$1844
CAB12070	1200	700	900	0	\$1509
CAB15070	1500	700	900	0	\$1764
NEW CABBQ16070	1600	700	900	3	\$2299
CAB16070	1600	700	900	0	\$1889
CAB18070	1800	700	900	0	\$2049
CAB20070	2000	700	900	0	\$2279
COFFEECART	1600	700	900	0	\$2469



Code: CAB2000

2000 (L) x 610mm (D) \$2699
4 drawers.
Adjustable internal shelf.
Shown with lockable castors.

610mm Deep Cabinets to match 610mm Benches & Sinks

- Nice deep drawers with solid runners.
- Choose castors for a mobile cabinet.
- Adjustable internal shelf.



Code: CAB24904D

2490 (L) x 610mm (D) \$3319
4 Drawers. Adjustable internal shelf.
Shown with adjustable feet.

Code	Length (mm)	Depth (mm)	Height (mm)	Drawers	PRICE*
CAB900	900	610	900	2	\$1599
CAB1200	1200	610	900	2	\$1839
CAB1500	1500	610	900	3	\$2099
CAB1800	1800	610	900	3	\$2434
CAB2000	2000	610	900	4	\$2699
CABCU*	1000	1000	900	1	\$1849
CAB20003D	2000	610	900	3	\$2804
CAB24904D	2490	610	900	4	\$3319

** CABCU is supplied without sides for use with cabinets or bench.

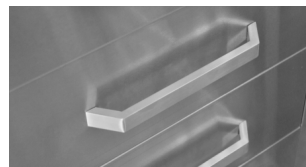

Drawer Detail

Attractive Handles.
Strong smooth runner.
Plenty of storage space.



CABCU \$1849

*Prices include GST. Prices vary due to raw material and exchange rate fluctuations and are subject to change without notice.

MODULAR
Sinks, Cabinets & Benches



[fridge & coffee machine not included]

Code: COFFEECART

1600 (L) x 700mm (D) \$2469

Castors or feet.
3 drawers.

Fridge recess with back vent.
Hinged door for easy access.

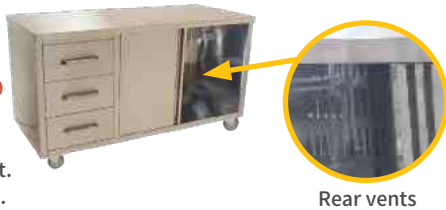

Rear vents

Wall Cabinets

430 grade stainless steel.

- 2 Sliding doors.
- 1 internal shelf.
- Adjustable height shelf.



Code	Length (mm)	Depth (mm)	Height (mm)	PRICE*
WALLCAB900	900	380	600	\$629
WALLCAB1200	1200	380	600	\$724



Community hall upgrade. CAB1500 used as an island workbench, with handy storage below.

Drawer Cabinets

to match 610mm Benches & Sinks

- Solid runners, nice deep drawers.
- Choose castors for a mobile drawer cabinet.



Code: CABRAW6

1000 (L) x 610mm (D) \$2144

Castors or feet.



Code: CABDRAW3

600 (L) x 610mm (D) \$1429

Castors or feet.

Code	Length (mm)	Depth (mm)	Height (mm)	Drawers	PRICE*
CABDRAW3	600	610	900	3	\$1429
CABDRAW6	1000	610	900	6	\$2144

Cabinets with Integrated Sink

to match 610mm Benches & Sinks



Code: CABSINKRB1500 \$1849

1500 (L) x 610mm (D), right bench.

Sink size: 400 x 400 x 250mm.

40 litre capacity.

Also available with left bench.

Code: CABSINKLB1500 \$1849



Code: CABSINK610 \$1094

610 (L) x 610mm (D)

Sink size: 40 x 40 x 25cm

40 litre capacity

Tap shown above:
Code: HANDFKM \$89

Code	Length (mm)	Depth (mm)	Height (mm)	PRICE*
CABSINK610	610	610	900	\$1094
CABSINKLB1500	1500	610	900	\$1849
CABSINKRB1500	1500	610	900	\$1849

Splashback Extension

Add a stainless steel splashback extension to prevent items falling down the back, or convert your cabinet to a corner unit. See page 7 for sizes and prices.



Overshelves

See page 3 for sizes and prices.



- Supplied with 2 shelves. Adjustable middle shelf.
- Extra shelves available.
- 800mm high - can be cut to reduce height.

Premium Coolroom Shelving



Rust Resistant

Our Premium Coolroom Shelves are made from a combination of plastic and aluminium making them rust and mould resistant. Perfect for wet areas.

Huge Load Capacity

Each shelf will hold a substantial amount of weight. Heavy duty aluminium rails and posts, plastic shelves and a patented locking system that ensures the unit carries the weight required in any kitchen.

Perfect for all your coolroom storage needs. Up to 250kg per shelf. (150kg per shelf for longer units.) For shelving with wheels 85kg per shelf. See website for further details.

Quick and Easy to Assemble

All components snap together with ease.

Suitable for Cold Temperatures

Premium shelving can withstand a temperature from -38 °c to 88 °c

Completely Versatile

Mix and match sizes and depths to fully maximise the space in your coolroom. You can even customise by cutting the shelf length to size. Corner attachments mean fewer posts allowing for better access.

Dishwashable

All slats are easy to remove which makes cleaning a breeze. Wipe clean any spills or just pull out and wash in the sink or dishwasher.

Adjustable Height Shelves

Each shelf is fully height adjustable. Each bay comes with 4 shelves and it's easy to add more to suit your storage needs

Adjustable Feet

Supplied as standard and adjustable up to 30 mm.

Resistant to rust and mould.

Load capacity up to 250kg!

Mix and match sizes and depths to suit your space.



Mobile units



Adjustable feet



NO CORNER POSTS
More access to your space.



Code: CAST5INC
Set of 4 Castors \$156

1700mm High Shelving



Code	Length (mm)	Depth (mm)	1st Bay PRICE*	Extra Bay PRICE*	Shelf PRICE*
PS1436-17	925	355	\$609	\$489	\$89
PS1442-17	1075	355	\$664	\$540	\$104
PS1448-17	1225	355	\$744	\$620	\$124
PS1460-17	1525	355	\$864	\$740	\$154
PS1472-17	1825	355	\$944	\$820	\$174
PS1836-17	925	450	\$674	\$545	\$104
PS1842-17	1075	450	\$719	\$594	\$114
PS1848-17	1225	450	\$794	\$669	\$134
PS1860-17	1525	450	\$919	\$789	\$164
PS1872-17	1825	450	\$1019	\$889	\$189
PS1878-17	1975	450	\$1094	\$965	\$209
PS2436-17	925	610	\$784	\$650	\$129
PS2442-17	1075	610	\$834	\$699	\$139
PS2448-17	1225	610	\$904	\$774	\$159
PS2454-17	1375	610	\$984	\$850	\$179
PS2460-17	1525	610	\$1084	\$950	\$204
PS2472-17	1825	610	\$1154	\$1019	\$219
PS2478-17	1975	610	\$1184	\$1050	\$229

2000mm High Shelving



Code	Length (mm)	Depth (mm)	1st Bay PRICE*	Extra Bay PRICE*	Shelf PRICE*
PS1436-20	925	355	\$659	\$514	\$89
PS1442-20	1075	355	\$714	\$565	\$104
PS1448-20	1225	355	\$794	\$645	\$124
PS1460-20	1525	355	\$914	\$765	\$154
PS1472-20	1825	355	\$994	\$845	\$174
PS1836-20	925	450	\$724	\$570	\$104
PS1842-20	1075	450	\$769	\$619	\$114
PS1848-20	1225	450	\$844	\$694	\$134
PS1860-20	1525	450	\$969	\$814	\$164
PS1872-20	1825	450	\$1069	\$914	\$189
PS1878-20	1975	450	\$1144	\$990	\$209
PS2436-20	925	610	\$834	\$675	\$129
PS2442-20	1075	610	\$884	\$724	\$139
PS2448-20	1225	610	\$954	\$799	\$159
PS2454-20	1375	610	\$1034	\$875	\$179
PS2460-20	1525	610	\$1134	\$975	\$204
PS2472-20	1825	610	\$1204	\$1044	\$219
PS2478-20	1975	610	\$1234	\$1075	\$229

*Prices include GST. Prices vary due to raw material and exchange rate fluctuations and are subject to change without notice.



Assembly is easy
Scan to watch the
assembly video now!

Fits Any Space • Strong • Washable



Extra Bay

VERSATILE SHELVING

Simply add an extra bay to your 1st Bay for a straight configuration. Use a connector pack to create an 'L' or 'U' shape.



Shelving in straight configuration. 1 complete bay with extra bays added.



How to Create Your Configuration

STEP 1: Measure the two or three walls you wish to fill and decide on the depth (355, 450 or 610mm) and height (1700, 2000 or 2450mm).

STEP 2: Decide on how many complete bays, extra bays or extra shelves you will need to create your shelving configuration:

'U' Shape: To create a 'U' shape configuration you will need 2 complete bays and additional shelves for the middle of the 'U' shape (see below). And simply order a connection pack to fit the depth of each complete unit.

'L' shape: When connecting the 1st Bay to the Extra Bay to create an 'L' shape you will need 1 connector pack for the depth of the 1st bay. The connector pack contains 2 Corner Connectors and 2 Plate Slats with slots for each shelf.

Straight: Simply add your extra bay to the end of the 1st Bay. No extra parts are required.

Confused? Our friendly Staff are here to help. Call us today.

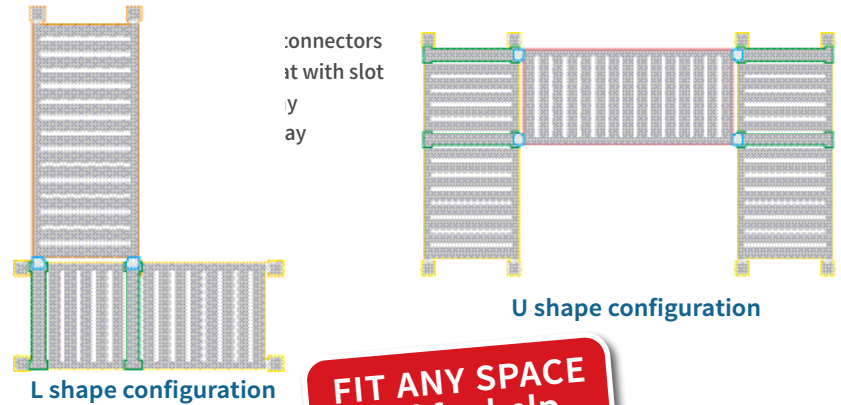

FIT ANY SPACE call for help

Accessories

Create a Corner

You will need to replace 2 slats on each shelf of your 1st bay with 2 plate slats with a slot (to accommodate the corner connector, see right).

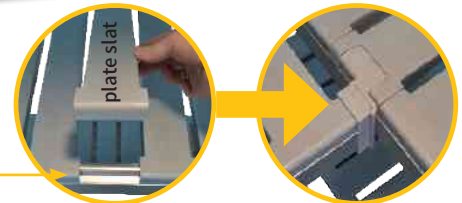

Connector packs contain 8 corner connectors + 8 plate slats with slots. Note: Choose a connector pack for the depth of your 1st bay.

Code	Connector Pack	PRICE*
CNRCONPACK355	(8 connectors + 8 slats with slots)	\$84
CNRCONPACK450	(8 connectors + 8 slats with slots)	\$92
CNRCONPACK610	(8 connectors + 8 slats with slots)	\$100

Purchase extra connection parts for your unit or create a mobile unit with hard wearing castors.

Code		PRICE*
CNRCON	Corner connectors (pair)	\$16.90
PLATE355	1 X 355mm plate slat with slot	\$5.20
PLATE450	1 X 450mm plate slat with slot	\$6.50
PLATE610	1 X 610mm plate slat with slot	\$7.80
CAST5INC	5 inch castor (set of 4)	\$156



2450mm High Shelving

Code	Length (mm)	Depth (mm)	1st Bay PRICE*	Extra Bay PRICE*	Shelf PRICE*
PS1436-24	925	355	\$699	\$529	\$89
PS1442-24	1075	355	\$744	\$580	\$104
PS1448-24	1225	355	\$824	\$660	\$124
PS1460-24	1525	355	\$944	\$780	\$154
PS1472-24	1825	355	\$1024	\$860	\$174
PS1836-24	925	450	\$764	\$590	\$104
PS1842-24	1075	450	\$809	\$634	\$114
PS1848-24	1225	450	\$884	\$710	\$134
PS1860-24	1525	450	\$1004	\$834	\$164
PS1872-24	1825	450	\$1104	\$934	\$189
PS1878-24	1975	450	\$1184	\$1010	\$209
PS2436-24	925	610	\$884	\$700	\$129
PS2442-24	1075	610	\$924	\$749	\$139
PS2448-24	1225	610	\$1004	\$820	\$159
PS2454-24	1375	610	\$1084	\$900	\$179
PS2460-24	1525	610	\$1184	\$1000	\$204
PS2472-24	1825	610	\$1254	\$1069	\$219
PS2478-24	1975	610	\$1284	\$1100	\$229



Plastic Dunnage Racks

Protects goods and packaging from contamination and moisture. See page 19 for more info.



Confused? Please call and we can help.

Coolroom/Dry Store Shelving

15% THICKER
Compare the quality!

The very familiar shelving system at a not-so-familiar price.

Stronger than competing systems.



Supplied With 4 Shelves
Shelves can be set to any height on the posts.

Adjustable Feet
The adjustable feet are perfect for uneven floors.



Shelves are supported by our special strong black clip which prevents the shelves sliding down. **STRONG**

Chrome or Epoxy?

Chrome looks absolutely fantastic but is a little more expensive.

Commonly used in retail areas where they need to look good. It is also popular in a variety of commercial settings, including storerooms, kitchens, and offices. Chrome shelving is not only attractive, but it is also very well-made and durable. It is also worth noting that chrome shelving is only appropriate for dry conditions with no humidity or dampness.



Epoxy shelf units are excellent for coolrooms or refrigerated environments, and cheaper too. They have a temperature range of -20°C to 200°C.

The rubberised coating offers water resistance, making them suitable to be used in both wet and dry conditions. This also protects against rust and corrosion.

A cost effective solution for coolrooms, garages, sheds, food storage, and warehouses.



Code: SH1872CH
1829 (L) x 457mm (D) \$444
Set of 4 Castors \$59

Chrome Wire Shelving for Dry Store

Code	Length (mm)	Depth (mm)	Height (mm)	PRICE*	Extra Shelf
SH1818CH	457	457	1800	\$214	\$44
SH1836CH	914	457	1800	\$279	\$69
SH1848CH	1219	457	1800	\$329	\$79
SH1860CH	1524	457	1800	\$384	\$119
SH1872CH	1829	457	1800	\$444	\$129
SH2424CH	610	610	1800	\$269	\$59
SH2430CH	762	610	1800	\$314	\$74
SH2436CH	914	610	1800	\$329	\$84
SH2448CH	1219	610	1800	\$409	\$109
SH2460CH	1524	610	1800	\$474	\$154

Epoxy Coated Wire Shelving for Coolrooms/Dry Store

Code	Length (mm)	Depth (mm)	Height (mm)	PRICE*	Extra Shelf
SH1236EP	914	305	1800	\$199	\$44
SH1248EP	1219	305	1800	\$224	\$59
SH1260EP	1524	305	1800	\$259	\$64
SH1818EP	457	457	1800	\$179	\$39
SH1830EP	762	457	1800	\$224	\$49
SH1836EP	914	457	1800	\$234	\$59
SH1848EP	1219	457	1800	\$284	\$69
SH1860EP	1524	457	1800	\$324	\$99
SH1872EP	1829	457	1800	\$364	\$119
SH2424EP	610	610	1800	\$214	\$49
SH2430EP	762	610	1800	\$234	\$64
SH2436EP	914	610	1800	\$274	\$69
SH2448EP	1219	610	1800	\$339	\$84
SH2460EP	1524	610	1800	\$404	\$134



Code: SH1836EP
914 (L) x 457mm (D)
\$234

Code: SH1818EP
457 (L) x 457mm (D)
\$179

Castors

Create a mobile unit with a choice of castors.



2 lockable & 2 non lock castors per set.

Castors SHWHEELS (set of 4) \$59

Heavy duty castors SHWHEELS-HD (set of 4) \$99

SHWHEELS	Set of 4 Castors	\$59
SHWHEELS-HD	Set of 4 Heavy duty castors	\$99

70,000 + sold



Wire Shelving FAQs

How do you put them together? Can I put the shelves at any height?

Each shelf comes with four clips. Simply snap lock them onto the grooves on the upright posts. Slide the shelf over the post until they hit the clip, apply a bit of pressure and the shelf is locked in place. You can put the shelves anywhere along the upright to suit the required shelf height.

Can I buy extra shelves?

Of course you can! See the price charts below left.

What are the load capacities of wire shelving?

Load capacities are 150kg per shelf.

For shelving with wheels the overall weight capacity of the unit is 240kg (**SHWHEELS \$59**)

or 320kg with the heavy duty wheels(**SHWHEELS-HD \$99**).

Higher capacity shelving (up to 250kg) is now available with the Premium Coolroom Range on page 14.

What if I have an uneven floor?

Each post has a small adjustable foot. Simply screw it out to level your shelves on an uneven floor.

How are these shelves made?

These shelves are made of steel, then dipped in either chrome or an epoxy resin.



Shelf Dividers

Keep your items organised and safe with shelf dividers.

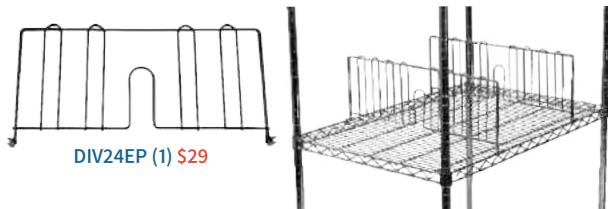

DIV24EP (1) \$29

Code	Length	Height	PRICE*
DIV18EP (epoxy)	457	230	\$24
DIV24EP (epoxy)	610	230	\$29
DIV18CH (chrome)	457	230	\$29
DIV24CH (chrome)	610	230	\$34

Posts

Purchase posts and shelves individually. 4 posts are needed for each bay.

Code	Height	PRICE*
CHLEG Set of 2 chrome posts	1800mm	\$34
EPLEG Set of 2 epoxy posts	1800mm	\$32



S Hooks

Connect your shelving bay to another bay with these handy epoxy or chrome hooks.

To attach additional bays you only need to add two legs and shelves to an existing complete bay. Buy these components separately to save on costs!

To use our S hooks you will need two hooks per shelf. Simply attach the hook to the shelf of a complete bay and lift the next bay onto the hook. Firmly push them into place to secure.



Code	Description	PRICE*
S-HOOKSEP2	Set of 2 epoxy hooks	\$6
S-HOOKSCH2	Set of 2 chrome hooks	\$6



Using these hooks in an L or U shape means you will have full access to the inside corner without a corner post in your way.

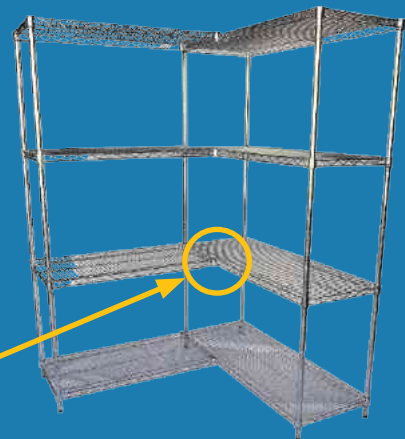

For an L shaped or multiple straight bays, use 1 complete unit and 1 another unit with just 4 shelves and 2 posts. Connect the shelves onto the complete unit with 8 hooks (2 per shelf).

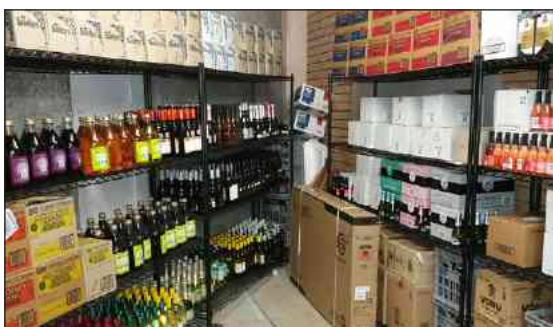

Heavy duty shelving fits spaces even triangle ones.

*Prices include GST. Prices vary due to raw material and exchange rate fluctuations and are subject to change without notice.

In a time where people are often so quick to criticize, it was so refreshing to receive a level of service that I can only describe as "breakthrough". Thank you Brayco for restoring faith in the concept of customer service. It is rare nowadays. You really did make my day. Better still, I am expecting delivery tomorrow. How good is that? Thanks again." Daryl



Experience the Magic
Scan to watch the assembly video now!

Trolleys & Trolley Bins

Cheapest Trolleys In NZ!

Stainless Steel Trolleys



Recessed trays
• Keep items secure.



Lockable castors



Screw in trays
• Strong.



TR2TIER \$419



TR3TIER \$524

Same high quality, heavy duty lockable castors as our benches, so they take a big load.

- Lockable castors (4).
- 1090mm long including handles.
- Load capacity 35kg per tray.
- 1mm thick 304 food grade stainless steel trays.
- Handle height 920mm.
- Tray size 870 x 420mm.

Code	Tray Size	Measurements	Tiers	PRICE*
TR2TIER	870 x 420mm	1090 x 480 x 920mm	2	\$419
TR3TIER	870 x 420mm	1090 x 480 x 920mm	3	\$524



TR2TIERN \$274



TR3TIERN \$339

Medium duty trolleys - cheaper, squarer trolleys that can still take a sizeable load.

- Lockable castors (2).
- Load capacity 25kg per tray.
- 0.8mm 430 grade stainless steel trays.
- Handle height 950mm.
- Tray size 825 x 505mm.

Code	Tray Size	Measurements	Tiers	PRICE*
TR2TIERN	825 x 507mm	910 x 580 x 950mm	2	\$274
TR3TIERN	825 x 507mm	910 x 580 x 950mm	3	\$339

** Note: Dimensions include handles

Polypropylene Trolleys & Bins

Heavy duty trolleys, suitable for coolrooms in an easy clean polypropylene.



TR3TPL \$259 shown with:
LEFT: **PPBINC** Cutlery Bin \$18
RIGHT: **PPBINR** Refuse Bin \$31



- Easy-clean polypropylene.
- Handle height 980mm.
- Load capacity 40kg per tray.
- Tray size 890 x 510mm.
- Easy assembly.
- 1030mm long including handles.
- Save space with robust bins.

Code	Tray Size	Measurements	Tiers	PRICE*
TR3TPL	750 x 510mm	1030 x 510 x 980mm	3	\$259
PPBINC	8 Litre	335 x 231 x 180mm	cutlery bin	\$18
PPBINR	20 Litre	335 x 231 x 445mm	refuse bin	\$31



TR3TPS \$199



TR3TPS-S \$249

- Easy clean compact polypropylene trolley with optional enclosed sides - keep your load secure.
- Handle height 850mm.
- Tray size 690 x 410mm.
- Easy assembly.
- 823mm long including handles.
- Load capacity 40kg per tray.
- Save space with robust bins.

Code	Tray Size	Measurements	Tiers	PRICE*
TR3TPS	615 x 410mm	823 x 410 x 850mm	3	\$199
TR3TPS-S	615 x 410mm	823 x 410 x 850mm	3+3 sides	\$249
PPBINC	8 Litre	335 x 231 x 180mm	cutlery bin	\$18
PPBINR	20 Litre	335 x 231 x 445mm	refuse bin	\$31

Medical Trolley

Ideal for medical and dental surgeries, hospitals, schools, food preparation areas and any other environment that requires a high level of hygiene. Our Medical Trolleys are built to last, they will keep your items secure and are easy to manoeuvre.

"Just like to thank your company for the swift service I received from Brisbane when I required a trolley. The trolley fits the purpose for my medical equipment in the home and I have recommended it to the unit if co-patients require one. Thank you."
Jose

- Perfect for the transfer of clinical supplies and patient care.
- Easy glide lockable castors.
- High grade stainless steel.
- Easy clean, hygienic surfaces.
- Rounded corners to lessen impact damage.
- Supplied flat packed, with simple assembly instructions and tools supplied.

HYGIENIC stainless steel

Code	Measurements	Shelf	Drawer	PRICE*
MEDTROL-SM	762 x 762 x 900mm	1	1	\$924
MEDTROL-MED	914 x 610 x 900mm	1	1	\$939



Plastic Dunnage Rack

Protects goods and packaging from contamination and moisture.

- Connect racks securely with connectors to fill your space.
- Allows air to flow – holey top ensures maximum circulation.
- Heavy duty polypropylene.
- Keep frozen, cool or dry products off the floor for improved hygiene.
- Rust resistant.



Code	Size	Load Capacity	PRICE*
DUN915	915 x 555 x 300mm high	600kg	\$369
DUN122	1215 x 555 x 300mm high	1200kg	\$519
DUNCON	Connector		\$10



Did You Know?
Brayco has a sister company . . .



Stools & Bar Tables

Dining Tables & Chairs



Outdoor Tables



Durable Furniture

\$99
table top



\$99
table base



\$59
chair

See The Full Range at Chairforce.co.nz



22 years ago,
I ordered the first container of stainless steel benches
and Brayco was born. . .

Together, We Have Made a Truly Impressive Sandwich

22 years ago, I ordered the first container of stainless steel benches and Brayco was born. That container had 8 stainless benches in it, no sinks, just benches.



When it arrived, I wasn't disappointed with the quality, so I shoved a few ads in the local papers and put up a few auctions on eBay to see how these few products would sell. Well, bugger me, the phones starting ringing and within 6 weeks, I was back

ordering the second container. I drafted my Brother In Law Dan in to help sell them. This container had 15 products. I was going out on a limb now. Now we had some wall shelves and a single cabinet crammed in. What recklessness! My wife and a few of my friends started asking whether I would saturate the market.

**Who would want that many stainless steel benches?
Why are they so popular?**

These are disturbing questions. When you've found something you like doing and it's going well, you don't like to think it'll just fizzle out. The fun part of business is the growth. The connection with colleagues and customers. So, I started asking the customers why the hell they were buying so many benches from us. If I didn't know the answer, maybe they would.

Could we do even better? Could we grow?

The customers said it basically came down to 4 simple things:

- 1. Quality** The benches had to be good quality — sturdy, built for purpose and durable.
- 2. Price** We were priced well below the lazy competitors who'd been price gouging for decades.
- 3. Availability** Customers liked being able to get their stuff same day, not wait for weeks.
- 4. Range** We had an OK range of sizes, but they would have bought more if we had more to offer.

So, armed with this knowledge, we decided to make sure we followed these 4 ideas. We call them the 4-Pillars.

And now, 20 years later, you can see the result.

- Those 8 products have turned into a mind boggling range of over 1,200 products. Benches, sinks, shelves, cabinets, chairs, tables, wheels and taps in a vast assortment of sizes, styles, materials. So, range is covered.

- In 2003, we had a 96 square metre warehouse in Perth. Pokey. Now, we have over 20,000 sqm of warehousing across Australia and New Zealand — we are available. Pick it up same day. Buy online. Ring. Whatever.
- And price? Well, in 2005 our smallest bench was \$199. Today, despite a pandemic, a global financial crisis, and rampant inflation across wages, warehouse costs, freight and everything else thrown up at us, that same bench is \$249. And we'll bring the price down if we can.
- As for quality, we have tirelessly worked to improve the strength and quality of the products we sell. Crap doesn't sell for long. And if something goes wrong we'll fix it.

The result of all this? Each year now, we expect to sell over 24,000 shelving units, over 50,000 benches, sinks and cabinets and 60,000 chairs. That's a lot. Hard to visualise, but let's give it a go. . .

Let's imagine that we got all of our customers together to make a sandwich, the biggest sandwich in the world. The current world record for the biggest sandwich is 74 metres. But I think we can do better.



Let's put all the benches together that you guys have bought in one long line to form the longest bench. If we started building it on the outskirts of Newcastle, then it would wind its way down the coast through Sydney and end up somewhere in the middle of Wollongong. The bench would be 255,000 metres long. That's quite a big bench. And we'd need a lot of butter. And a lot of people. And let's hope there isn't a shortage of lettuce when we do it.

But luckily, we have a lot of customers that might pitch in to help. There are 143,412 current customers of Brayco and Chairforce, enough to fill both the MCG and the SCG. If we all pitched in, I think the sandwich wouldn't take long to make at all. Wouldn't take long to eat it either.

So, thank you lovely customers. The Brayco team are wholly reliant on your goodwill and continued custom. We hope to earn it. We are committed to the 4-pillars approach — and hopefully, together, in another twenty years time, we can make a sandwich to stretch from Sydney to Melbourne and beyond.

Harry Bray,
Director

Contact Your NZ Brayco Outlet Today . . .

9 Nandina Avenue
East Tamaki AUCKLAND

Open 9 – 5pm
Monday to Friday

09 271 5000

sales@braycostainless.co.nz

www.braycostainless.co.nz

SHOP ONLINE www.braycostainless.co.nz

After your order has been placed online you will receive an email confirmation, followed by a call to confirm when your order will be dispatched, is ready for collection, or the final shipping cost if we can't give you an instant cost via the website.

ORDER BY PHONE 09 271 5000

Give us a call and we can place your order immediately and answer any questions you may have.

VISIT US

Come and see us. We can show you the range and help with your order. Bring your plans if you need help fitting it all in. Open Monday to Friday, 9am to 5pm.

HAVE A QUESTION?

We love to talk stainless. Chat live to our friendly Customer Service Team via the website, or give us a call.